

# Kewaskum Statesman

"Gateway to the Kettle Moraine State Forest"

Volume 82

Kewaskum, Wisconsin Friday, January 27, 1978

Number 5

## Week's Wit

As one strawberry said to the other strawberry: "If we hadn't been in the same bed, we never would be in this jam."

## Brewers' Cecil Cooper to Appear At Kewaskum's Baseball Night

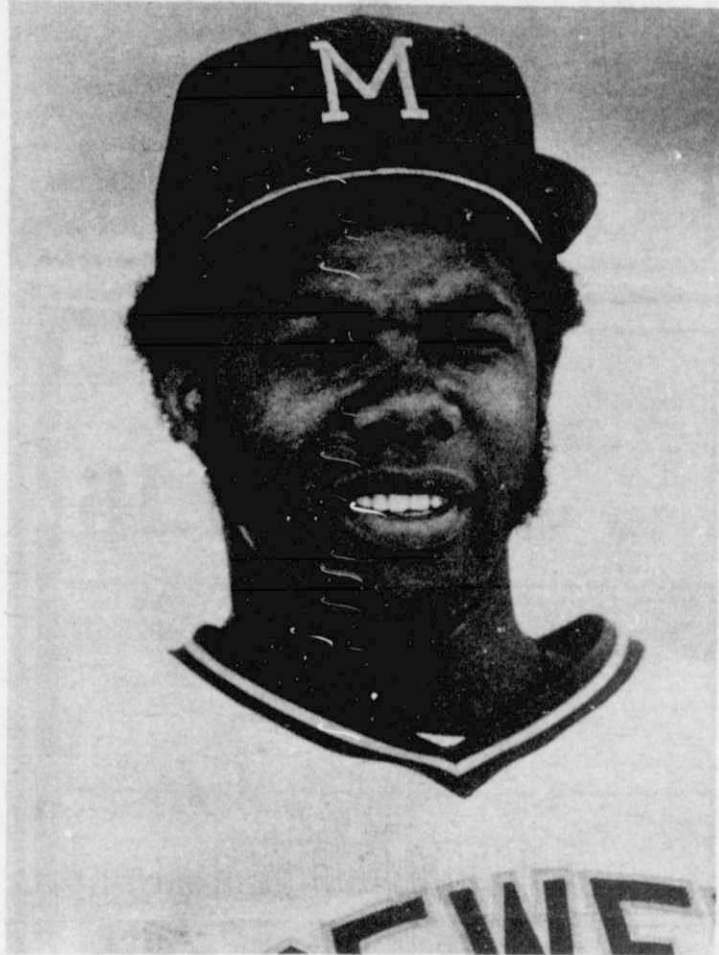

Cecil Cooper, star Milwaukee Brewer first baseman, and Dick Hackett, Public Relations Director for the Brewers, will appear at Kewaskum's Baseball Night, sponsored by the Kewaskum Chamber of Commerce, on Monday, Feb. 13, at the Amerahn.

There will be a buffet dinner served at 6:30 p. m. The charge is \$3.25 per person and registration arrangements should be made at the Valley Bank by Feb. 1. Payment must be made at the time of registration.

The program, featuring Cooper and Hackett, is free and will begin at 7:15 p. m. They will be on hand to present a film and discuss the Brewer Baseball Club. Cooper will later autograph pictures for the youngsters.

Cecil Celester Cooper enjoyed his finest season in 1977, becoming the Brewers' first 300 hitter since George Scott (.306) and Davey May (.303) accomplished the feat in 1973. He not only led the team in hitting, but he also topped the club with 160

games played and 193 hits and ties for the team lead in runs (86) and triples (7). His 193 hits was a Brewer season record, surpassing the old record (189) set by Davey May in 1973. He needed one hit on the final day of the season to break the record and went out in style, going 4-for-4. He also set personal highs with games played, at bats, runs, hits, doubles (31), triples, homers (20) and RBIs. He spent three full seasons with Boston before joining the Brewers in the George Scott and Bernie Carbo trade in December of 1976. He hit .275, .311 and .282 with the Red Sox and upped his major league career percentage to .289. He led the league's designated hitters in 1975 with a .318 average. Born on December 20, 1949 in Brenham, Texas, Cecil and his wife, Octavia, are expecting their first child this winter. They are currently residing in Mequon during the off season, and Cecil is working for the Brewers in ticket sales and public relations.

## Exchange Student Leaves for Home

Linda Getz, who spent the first semester of her senior year in Kewaskum under the AFS (American Field Service) domestic program, left for home Saturday. Her host family here was the Floyd Brenholts. Joanne, one of six Brenholt children, was her senior "sister."

Linda comes from Shrews-

bury, Pa., a community of about 4,000 people. This week she returned to Susquehannock High School, whose enrollment is around 800 students. She will graduate this spring and hopes for a career in fashion design and her own shop some day.

Linda flew back to Pennsylvania on Saturday.

## Local Historical Society Meets, Elects Officers

On Jan. 17 the Kewaskum Historical Society held its first meeting for 1978.

The evening's agenda called for the election of officers and they are as follows:

President — Cliff Stautz;  
Vice-President — Bob Schultz;  
Secretary — Gloria Rodenkirch; Treasurer — Kathy Paul.

Dan Schmidt was elected to the three-year term of the Board of Directors: Marshall Reysen will complete Bob Schultz's unexpired director term.

The society wishes to acknowledge the donation of a gigantic bellows, farming cone and other related blacksmith tools from Mr. and Mrs. Al Muckerheide. A blacksmith display is now in the beginning stages and, hopefully, will be completed for the summer tours.

A collection was taken among members present to give to the society as a memorial to Jim Paul's father, who passed away recently. It will be a continuing practice of the society to give a memorial to the family of a member or their family on their passing.

The public is invited to attend any of the meetings which are held on the third Tuesday of each month at 8 p. m. in the Valley Bank basement.

## Dr. Edwards Named to Cerebral Palsy Board; Telethon Scheduled

KEWASKUM — Dr. R.G. Edwards of Kewaskum has been selected to the board of directors of the United Cerebral Palsy of South Eastern Wisconsin, Inc.

He has also been asked to be on the board of Developmental Disabilities Services, Inc. of Washington County, and with the news of his UCPSEW board appointment also comes the announcement of the second annual Cerebral Palsy Telethon Feb. 4 and 5 on WISN-TV Channel 12. It will start at 10:30 p.m. Saturday and continue live to Sunday at 6 p.m.

"The plight of the palsied children is so often not understood by the general public," said Edwards. "Some of them think all such handicapped children are also mentally retarded."

"This is not true and that is why we will have the 19½ hour telethon...to teach you, by visual instruction what many of these people can do and what some have accomplished," he said.

For example: the autobi-

## Tom Kennelly Named One of Five Outstanding Young Men in State

Thomas C. Kennelly, of 5209 Little Cedar Lane near Little Cedar Lake, who is president of the Kennelly Pharmacies in Hartford and Kewaskum, was named one of five Outstanding Young Men in Wisconsin Jan. 21 at the annual Jaycee convention in Eau Claire.

Kennelly was nominated by the Hartford Jaycees for leadership and contributions to his community. He was Hartford's Outstanding Young Man of 1977.

A registered pharmacist, he is also licensed to train pharmacy interns. He is currently the pharmacist consultant for Gateway Nursing Home in Hartford and belongs to several pharmaceutical societies and associations.

Since 1969 he has been an active member of the Hartford Jaycees, holding several key positions, including president in 1973-74 and most recently Orientation and Cystic Fibrosis Chairman. As president, he led his chapter to sixth best in the state and received the Geissenbier Award as the most outstanding chapter in his population division.

Kennelly has also been involved in civic affairs since coming to Hartford in 1968. He has served as vice president of the Hartford Businessmen's Ass'n. and pro-

motion chairman of the Businessmen's Committee. Most recently he served as treasurer of the Hartford Area Chamber of Commerce.

In 1975 the mayor appointed him to the Hartford Planning Commission where he was chairman.

He has been active on the church council of Peace Lutheran Church in Hartford for six years in many capacities. He has worked with the convalescent and aging committee of the Wisconsin Lutheran Child and Family Service, and has spoken to numerous groups on topics ranging from career opportunities to family health needs.

Kennelly recently moved from Hartford to the Little Cedar Lake area with his wife Elaine and their two sons.

Other outstanding young men named at the convention from ten finalists were: Edward J. Fink, Richland Center; Ronald E. Glasgow, Janesville; Robert W. Kasten, Thiensville; and Stephen A. Tonrio, Oconto.

All are eligible, if nominated by their home chapters for possible national recognition.

## Accepted Into Baccalaureate Nursing Program



Verna Bowman, daughter of Mr. and Mrs. Glannis Bowman, R. 1, Kewaskum, has been accepted into the Baccalaureate Program of Nursing. She attends Olivet Nazarene College in Kankakee, Ill.

Acceptance is determined by scholastic record of the past 1½ years of college work. Verna has been named to the Dean's List by maintaining above a 3.35 grade point average.

She is a 1976 graduate of Kewaskum High School.

(Continued on Page 2)



## Dr. Edwards

(Continued from Page 1)

five percent will remain in the community for local program service, the release said, and 25 percent will be directed into major medical research, public education and advocacy programs at a national level.

"Hundreds of volunteers will be needed to work," it said, and interested groups and individuals should call 272-4500.

## Junior Women Offer Lenten Bible Study

A Lenten Bible Study will be offered for women in our community, sponsored by the Junior Woman's Club of Kewaskum at the home of Isabelle Straub, 1035 Hillside Drive. This will be a six week study beginning on Tuesday, Feb. 7, at 10 - 11:30 a. m. and meeting consecutively thereafter.

This is to be an informal study taken from the Book of James, entitled "Christianity: A Practical Religion." Participants are encouraged to use any translation or modern paraphrased edition of "The Bible" that they are comfortable reading. This study is designed to help adults understand, appreciate and participate more joyfully in the celebration of Lent. The Jr. Woman's Club invites women of the community to join us in this opportunity for renewal of strength and a joyful relationship with God and with others during the Lent - Easter season.

For registration, additional information and to inquire about nursery care during this event, call 626-4232 or 626-4395. Pre-registration is requested but not required.

## FIREMEN'S MEETING

The regular monthly meeting of the Kewaskum Fire Department will be held at the fire station at 7:30 p. m. Thursday, Feb. 2.



JOHN BORAY, R. Ph.

Cholesterol is a fatty material blamed for clogging up arteries and so causing heart attacks. An Anti-Coronary Club in New York of 814 men, age 40 to 59, followed a low-fat diet for seven years with only seven of the men dying of heart attack. Of a control group of 420 men who kept their old diets, 12 died of heart attack in the same period — three times the rate of the low-fat diet group.

**Kennelly Pharmacy**  
PHARMACY CENTER

## Board of Education Meeting on Monday

A meeting of the Kewaskum Board of Education will be held at 8 p. m. on Jan. 30, in the district administration office.

Agenda items for the meeting will include further consideration of the transportation question dealing with walking distances. Approval of a Title IV-B project, payroll and vouchers payable, approval of a driver education teacher, and the possibility of a full-time substitute teacher under the CETA program will also be considered. Richard Theusch will report to the board on the WASB convention and payroll and vouchers payable will be up for approval, as will the contract on the Beechwood roof repair. Other items which

come up will also be considered.

A closed session will be held after the regular meeting for teacher evaluations and a salary question.

## Rescue Squad Calls

Thursday, Jan. 19—Mrs. Walter Westerman, 67, 9322 Old Fond du Lac Road, Kewaskum, removed to St. Joseph's Community Hospital, West Bend, with illness.

Saturday, Jan. 21 — Stephanie Herman, 17, 4801 Victory Ave., Racine, removed to St. Joseph's Community Hospital from Sunburst Ski Hill with a skiing injury.

Saturday, Jan. 21 — Eric Vogel, 12, 1805 W. Bradley Rd., Milwaukee, removed to St. Joseph's Community Hospital from Sunburst Ski Hill

with a skiing injury.

Sunday, Jan. 22—Daniel Hollister, 21, R. 2, Kewaskum, removed to St. Joseph's Community Hospital with injuries suffered when he was struck by an auto on Hwy. 28, one-fourth mile east of Kewaskum.

Page 2  
Kewaskum Statesman  
Friday, January 27, 1978

Nylac cleans kitchen carpeting beautifully in 15 minutes. Dry in one hour. No machine. Ask Miller's of Kewaskum. adv.

## CARPET — UPHOLSTERY

### Cleaning Service

Professional  
Deep Steam\* Extraction  
No Soap Residue, Fast Drying  
Safe and Gentle for All Fibers  
Ask About Our  
Carpet Protection Treatment  
FREE ESTIMATES  
Residential - Commercial  
Call 338-0783 Anytime



Syl's Carpet & Upholstery Cleaning Svc.

We Welcome  
Food Stamp Shoppers



# Rosenheimer's Grocery

Enjoy A Vacation From Inflation!



Paradise  
of Food Values

WELCH'S GRAPE JAM or Grape 3 lb Jar 99¢

FRUIT COCKTAIL Del Monte 2 17 oz Cans 89¢

3-Diamond PINEAPPLE Sliced, Crushed or Chunk, in Own Juice 20 oz Can 53¢

HAWAIIAN PUNCH Fruit Drink 64 oz Jar 89¢

PUDDING CUP Del Monte Assorted 4 ct Pkg 79¢

HOLSUM DRESSING Assorted Flavors 16 oz Btl 94¢

MORTON DONUTS Glazed or Jelly-Filled 9-11 oz Box 63¢



Home-Made, Assorted  
SOUP  
STARTER

6-7 oz Package 73¢

CREAMETTES  
EGG NOODLES

Assorted Widths 1 lb Bag 49¢

CHEF BOY AR DEE Spaghetti & Meatballs 15 oz Can 49¢

FISH STICKS Mrs. Paul's, Frozen in Light Batter 21 oz Pkg \$2.09

FISH FILLETS Mrs. Paul's, Frozen in Light Batter 27 1/2 oz Pkg \$2.59

Fresh Produce... Eatin' Fun In The Tropical Sun!

Red GRAPEFRUIT 10/\$1.00

TOMATOES 39c lb.

Temple ORANGES 79c doz.

McIntosh APPLES 3 lb. bag 79c

FAIRMONT

GALLON

1% MILK

\$1.16

CHOPPED BEEF

99c lb.

Country Cupboard  
SLICED MEATS

2/89c

ALOHA!

Betty Crocker, Assorted

Cake Mixes

18.5 oz Box 59¢

Aunt Jemima, Complete  
Pancake Mix

2 lb Box 88¢

CAKE FROSTING Betty Crocker, Ready-to-Serve

24 oz Btl 85¢

PANCAKE SYRUP Aunt Jemima

16.5 oz Box \$1.24



Northern, Assorted Tints  
BATHROOM  
TISSUE

4 Roll Pkg 79¢

Here's A Hono-lulu Of A Sale!

COKE 8 pk. 16 oz. bottles \$1.09

Red Kidney Beans

Joan of Arc, Light or Dark 3 15 oz Cans \$1

Red Magic DEL MONTE CATSUP

26 oz Btl 69¢

Jumbo Decorated GALA TOWELS

1 roll Pkg 59¢

Detangler, 200 OZ PUREX LIQUID

64 oz Btl \$1.91

Chunk or Hi-Protein TUFFY DOG FOOD

25 lb Bag \$3.79

SAVE \$1.00 With This Coupon

Reg. Orp. Perk O Lect BUTTER-NUT COFFEE

3 lb Can \$8.98 With coupon

Offer good thru Sat. Jan. 29 L. Rosenheimer Limit please, 1 per family

SAVE 10c With This Coupon

100% Florida Orange Juice MINUTE MAID

32 oz Can 43c With Coupon

Offer good thru Sat. Jan. 29 L. Rosenheimer Limit please, 1 per family



## Barth - Broecker



The marriage vows of Kathy Barth, R. 1, Fredonia, and N. Allen Broecker, R. 1, Kewaskum, were blessed during a 1:00 p. m. double ring ceremony at St. Mary's Church, Little Kohler, on Saturday, Dec. 3. Father John Simon officiated.

Kim Steffen was the organist and the soloist was Mary Miller.

Parents of the couple are Mr. and Mrs. Roman Barth, R. 1, Fredonia, and Mr. and Mrs. Norbert Broecker, R. 1, Kewaskum.

Jean Abel, West Bend, a friend of the bride, was the maid of honor and Donna Broecker, R. 1, Kewaskum, sister of the bridegroom, was the bridesmaid.

Jim Barth, Sheboygan, brother of the bride, served as best man and the groomsman was Jeff Broecker, Mt. Calvary, brother of the bridegroom.

Ushering duties were shared by Don Barth, Fredonia, brother of the bride, and Lester Simon, Campbellsport, cousin of the bridegroom.

A reception was held at Nonn's Resort following the ceremony.

The bride is currently attending MPTI in Fond du Lac and her husband is employed at Sentry Foods in Kewaskum.

The couple spent their honeymoon in Miami Beach, Florida, and are now residing at 1416 Stark St. Kewaskum.

## Marriage License

David Arnold Amerling, Kewaskum, and Cindy Lu Gutjahr, Kewaskum; wedding Jan. 28.

## December Kiwanis Students of the Month



Suzette VanAssche

Suzette Van Assche, daughter of Mr. and Mrs. David VanAssche, and Robert Secor, son of Mr. and Mrs. Gerald Secor, both of rural Kewaskum, have been chosen as Kiwanis students for the month of December.

Suzette was a student government representative in her freshman and sophomore years. In her junior year, she was class treasurer and this year is vice president of the senior class. She belongs to the Future Teachers of America Club and this year serves as secretary. Suzette has been a cheerleader for four years and was captain for two years. She was involved in various productions at school including "Hello Dolly," "Music Man," "The Sound of Music," and "The Mouse

That Roared." Suzette has been a choir member for four years and sang with the Swing Choir during the past two years. She participated in track and gymnastics. She was a GAA member for two years and also a FHA member for two years. Suzette was on the homecoming court in her senior year.

Bob has been inducted into the National Honor Society. He participates in cross-country, wrestling and track and field. He is a member of the math team. Bob played in the Pit Band for "The Sound



Gerald Secor

of Music." He is a member of the Science Club. He was treasurer of his sophomore class and he is also treasurer of the National Honor Society.

## BLOOD PRESSURE SCREENING FEB. 1

A blood pressure screening by the county public health nurse will be held at the American Legion Clubhouse in Kewaskum on Wednesday, Feb. 1, at 11:00 a. m. until all are taken.

Anyone is welcome to come and have their blood pressure taken as there is no charge.

## JOCELYN'S PLASTERAMA

120 Main St.

Kewaskum

PHONE 626-4948

Plastercraft Items

Now Holding Classes

Every Wednesday, 7:00 - 9:00 p. m.

STORE Mon., Tues., Thurs. & Sat.—12:00 n - 6:00 p. m.

HOURS Wed., & Fri.—12:00 n - 9:00 p. m.

## Geri's

BEAUTY SALON

114 Main St.

Featuring

Helene Curtis UNIPERMS

in Savings & Loan Bldg.

(Rear Entrance)

PHONE 626-4455



a perfect love match



DIAMOND WEDDING SETS



By Feature Ring

BIER'S JEWELRY

626-2777

ILLUSTRATIONS ENLARGED

In 14 Kt. white or yellow gold

Now!

MIDWINTER SALE

Throughout Our Huge Store

GREAT SAVINGS



Where More People Find What They Want

Miller's

On Hwy. 45 in Kewaskum

Fine Furniture Since 1910

Open Daily to 5:30  
Mon. & Fri. to 9 p.m.

FREE DEPENDABLE DELIVERY  
AND ROOM PLACEMENT

**DENNIS' FAMILY SHOES**  
Kewaskum  
626-4332  
**BOOT SALE**

Inc. Mobil Boots #3<sup>00</sup> Off!  
M. in Leather Insulated Boots #5<sup>00</sup> Off!  
Ladies - Blue Waterproofer 1/4 Off!



## Peter Kohler, Mrs. Walter Westerman Die

Peter Kohler, 84, a resident of the Samaritan Home, West Bend, for the past three years, formerly of Kewaskum, died Wednesday evening, Jan. 18, at the Samaritan.

He was born June 28, 1893, at St. Killian, Town of Ashford. On Sept. 29, 1920 he married Estella Mathieu. She passed away Sept. 25, 1922. On Nov. 23, 1929, he married Rosaline Pfum at Holy Trinity Catholic Church, Kewaskum.

Surviving are his wife; three children, Mrs. Allen (Shirley) Dreher and Mrs. Frank (Paula) Kutz, both of Kewaskum, and Paul (Ruth) of West Bend; 11 grandchildren, and four great-grandchildren.

Also surviving are two brothers, Arthur of Milwaukee and Oscar of Long Lake; two sisters, Mrs. Philip (Theresa) Volm of St. Killian and Mrs. Alvin (Frances) Volm of Kewaskum; three sisters-in-law; three brothers-in-law; other relatives and friends. One sister preceded him in death.

Visitation was at Miller's Funeral Home, 215 Forest Ave., Kewaskum, after 4 p. m. Friday, Jan. 20, with rosary vigil at 8 p. m.

Funeral services were held at 10 a. m. Saturday at the funeral home and at 10:30 a. m. at Holy Trinity Church, Kewaskum. The Rev. John T. Budde officiated and burial was in Holy Angels Cemetery, West Bend.

### HELEN WESTERMAN

Mrs. Walter (Helen) Westerman, nee Batzler, 67, of R. 2, Kewaskum, passed away Friday, Jan. 20, at St. Joseph's Community Hospital in West Bend, where she had been a patient for one day.

Mrs. Westerman was born on Jan. 3, 1911 in the Town of Wayne to the late Mr. and Mrs. Wm. Batzler. On May 14, 1928 she married Walter

W. Westerman in Holy Angels Church in Milwaukee. She was employed at the Kewaskum Frozen Foods for the past four years.

She was a member of Holy Trinity Church, Kewaskum, the Christian Mothers, and Apostolate of Suffering.

Survivors include her husband; six children. Mrs. Ardell (Joseph) Fell of Kewaskum, Richard (Angeline) of West Bend, Mrs. Lorraine (Richard) Boden of Kewaskum, Lloyd (Roselyn) of Kewaskum, Mrs. Sally (Gerald) Doll of West Bend, and Mrs. Mary (Phillip) Hahn of rural Campbellsport, and 18 grandchildren. One sister preceded her in death.

Visitation at Miller's Funeral Home, 215 Forest Ave., Kewaskum, was after 3 p. m. Sunday with rosary vigil at 8:30 p. m. Services were Monday at 10 a. m. at the funeral home and at 10:30 a. m. at Holy Trinity Church, with Rev. John T. Budde officiating. Burial was in the new Holy Trinity cemetery.

### Hartwell Paul

Hartwell J. "Dutch" Paul, 66, of 1813 Mason St., New Holstein, died at 9:45 a. m. Tuesday, Jan. 17, 1978. He was dead on arrival at Calumet Memorial Hospital, Chilton, of an apparent heart attack.

Born at Cedarville, Mich., on April 16, 1911, he was a son of the late Archibald and Theresa Lobermeier Paul. He attended elementary and high schools in Fifield, Wis., graduating in 1929. He married Eleanor Cooley at Eagle River on Sept. 11, 1937, and she died on April 16, 1947.

Mr. Paul then married Sabina Thiessen at Milwaukee on June 17, 1950. He was employed as a game warden by the Wisconsin Conservation Department in Vilas County from 1929 to 1941, by the Pabst Brewing Co. of Milwaukee from 1941 to 1951, as a railway mail clerk on a mail train from Chicago to St. Paul, Minn., for seven years and as a rural Route 1, mail carrier at New Holstein for 13 years, retiring in July of 1973.

He was a veteran of World War II having served with the Naval Coast Guard from July of 1942 to November of 1945 outside the continental limits of the

United States. He was a member of Fifield American Legion Post 532 and Retired Rural Letter Carriers Association.

Surviving are his wife; a son, H. Jim of Kewaskum; four grandchildren; and a brother, Raymond of Milwaukee.

Funeral services were held at 4:30 p. m. Thursday at Erbe-Evjen Funeral Home, New Holstein. The Rev. Albert K. Borns of St. John's United Church of Christ at New Holstein officiated. Burial was in Fifield Cemetery.

Visitation for Mr. Paul was after 2 p. m. Thursday and until the time of services at the funeral home.

### Mrs. Olga Herberg

Mrs. Olga M. Herberg, 95, of 215 S. Main St., Mayville, died Monday, Jan. 23, 1977, at Clearview Nursing Home in

Juneau.

She was born on Dec. 30, 1882, at Kewaskum, a daughter of Nick and Lena Guth. In 1895, she and her family moved to Mayville, where her parents operated the American House. In 1907, she married Paul Herberg, who died in 1918.

Mrs. Herberg finished her husband's term as postmaster at Mayville and then worked as a postal clerk until retiring in 1945. She organized the Mayville Mothers Club in 1914 and served as its first president. During spring commencement exercises in 1976, Mrs. Herberg was honored as the oldest living graduate of Mayville High School. She was a member of the class of 1901.

Survivors include one son, Winfred of Mayville. In addition to her husband, who was preceded in death by one brother and four sisters.

Page 4  
Kewaskum Statesman  
Friday, January 27, 1978

The body was cremated and interment was in Graceland Cemetery at Mayville.

### REMINDER

The Land Use and Park Department is asking all who haven't sent in their Washington County Land Use Survey questionnaire, which was published in the Statesman Jan. 13, to kindly do so. It will be appreciated.

If you have misplaced your copy, they are still available at the Land Use Office, Courthouse Annex II, West Bend, phone 334-3491, extension 250. They will be happy to mail one to you.

### COUPON SPECIAL

1st in Washington County with  
Hunter Computerized Alignment Service

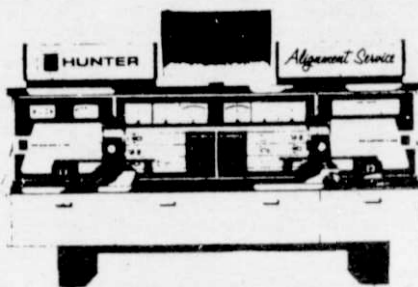

DONALD  
DICKMAN

15 years experience  
in auto mechanics  
and front end  
alignment



**12<sup>88</sup>** with coupon only  
\$15.00 without coupon  
Coupon expires Jan. 31, 1978



RAPID WHEEL  
BALANCERS

2<sup>99</sup> /wheel  
WITH COUPON  
EXPIRES 1/31/78

Hunter Rapid Wheel  
Balancer is recommended  
by Mechanix Illustrated  
magazine in the Jan.,  
1978 issue, page 108

**WAALA'S**  
Wheel & Tire Shop Inc.

1707 Schmidt Rd. (Barton)  
WEST BEND  
338-0662

# Home Buyers

Don't Let Higher Mortgage Rates Somewhere  
Else Cost You Money!

A 1/4% Difference In Rates Can Mean A  
Difference Of Almost \$2,000 In Total Pay-  
ments Made On A 30 Year Mortgage.

When You Buy A Home, Check With Us  
It Could Make Quite A Difference.



**KEWASKUM**  
**SAVINGS**

OFFICE OF WEST BEND  
SAVINGS & LOAN ASSOCIATION

The Largest Home Lender in Washington County  
MAIN STREET IN KEWASKUM — PHONE 626-2186

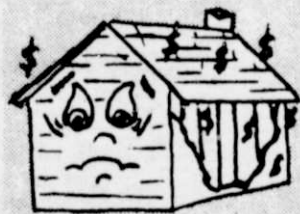

MAKE YOUR HOUSE A HAPPY HOME  
LET KETTLE MORAINÉ INSULATION

**HELP!**

**SUR COMFORT INSULATION**

For side walls and attics  
of New and Old Homes

We have treated and tested insulation  
to meet the recommended R-30 Value  
(8" - R-30)

90 DAYS SAME AS CASH

**Kettle Moraine Electric**

1261 Fond du Lac Ave. - Kewaskum

FOR A FREE ESTIMATE CALL:

KIM RODENKIRCH  
Kewaskum  
626-8007

HAROLD LINDLEY  
West Bend  
334-3363

CALL US AT  
THE STORE  
626-2093



# SENTRY

## January heat wave prices!

PRICES EFFECTIVE  
MON. JAN. 23  
THRU SUN.  
JAN. 29, 1978

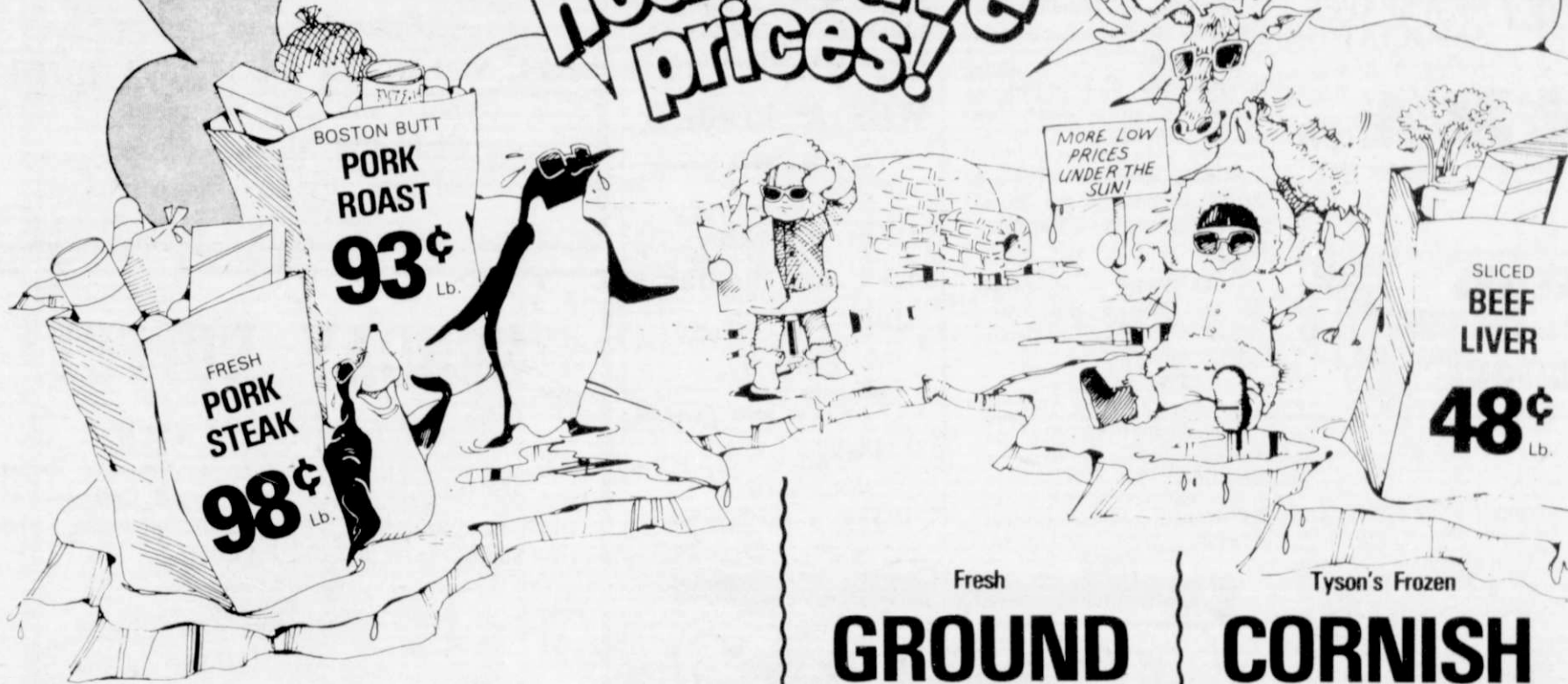

FRESH  
**Ground Round** . . . . . **\$1<sup>19</sup>** Lb.  
EXTRA LEAN  
**Ground Beef** . . . . . **98¢** Lb.  
DUBUQUE  
**Pork Sausage Roll** . . . . . **79¢** 1 Lb. Pkg.  
WEAVER  
**Chicken Hot Dogs** . . . . . **75¢** 1 Pkg.

Fresh  
**GROUND BEEF**  
**79¢** Lb.

Tyson's Frozen  
**CORNISH GAME HENS**  
**98¢** each  
22 Oz. Minimum Weight

**VALUABLE COUPON**  
S-19  
40 Oz. Overwrap Tray  
**McIntosh Apples** **88¢**  
With Coupon  
Valid at Sentry Through Jan. 31, 1978.  
Limit One Per Adult Cash Value 1/20¢

**VALUABLE COUPON**  
S-23  
On TWO 12 Oz. Cans  
Frozen SNOW CROP  
**Orange Juice** 2 for **\$1<sup>64</sup>**  
With Coupon  
Valid at Sentry Through Jan. 31, 1978.  
Limit One Per Adult Cash Value 1/20¢

**VALUABLE COUPON**  
S-27  
9 Oz. Twin Pak Bag  
FRITO-LAY  
**Potato Chips** **64¢**  
With Coupon  
Valid at Sentry Through Jan. 31, 1978.  
Limit One Per Adult Cash Value 1/20¢

**VALUABLE COUPON**  
S-32  
64 Oz. Bottle SENTRY  
**Fabric Softener** **88¢**  
With Coupon  
Valid at Sentry Through Jan. 31, 1978.  
Limit One Per Adult Cash Value 1/20¢

**VALUABLE COUPON**  
S-20  
10 Lb. Bag Wisconsin  
**Russet Potatoes** **78¢**  
With Coupon  
Valid at Sentry Through Jan. 31, 1978.  
Limit One Per Adult Cash Value 1/20¢

**VALUABLE COUPON**  
S-24  
26 Oz. Pkg. FROZEN  
MRS. SMITH'S  
**Apple Pie** **98¢**  
With Coupon  
Valid at Sentry Through Jan. 31, 1978.  
Limit One Per Adult Cash Value 1/20¢

**VALUABLE COUPON**  
S-28  
15 Oz. Box POST  
**Country Crisp Cereal** **75¢**  
With Coupon  
Valid at Sentry Through Jan. 31, 1978.  
Limit One Per Adult Cash Value 1/20¢

**VALUABLE COUPON**  
S-33  
32 Oz. Bottle Cold Water  
Wash  
**Woolite Liquid** **\$2<sup>44</sup>**  
With Coupon  
Valid at Sentry Through Jan. 31, 1978.  
Limit One Per Adult Cash Value 1/20¢

**VALUABLE COUPON**  
S-21  
3 Lb. Can Regular, Drip  
or Electric Perk  
**Hills Bros. Coffee** **\$8<sup>86</sup>**  
With Coupon  
Valid at Sentry Through Jan. 31, 1978.  
Limit One Per Adult Cash Value 1/20¢

**VALUABLE COUPON**  
S-25  
14 Oz. Pkg. Frozen JOHN'S  
**Sausage Pizza** **76¢**  
With Coupon  
Valid at Sentry Through Jan. 31, 1978.  
Limit One Per Adult Cash Value 1/20¢

**VALUABLE COUPON**  
S-29  
20 Quart Pkg. SANALAC  
**Instant Milk** **\$4<sup>72</sup>**  
With Coupon  
Valid at Sentry Through Jan. 31, 1978.  
Limit One Per Adult Cash Value 1/20¢

**VALUABLE COUPON**  
S-34  
On TWO 6 Oz. Size  
Assorted Air Freshener  
**Glade Solid** 2 for **69¢**  
With Coupon  
Valid at Sentry Through Jan. 31, 1978.  
Limit One Per Adult Cash Value 1/20¢

**VALUABLE COUPON**  
S-22  
16 Oz. Jar Non-Dairy Creamer  
**Coffee-Mate** **\$1<sup>03</sup>**  
With Coupon  
Valid at Sentry Through Jan. 31, 1978.  
Limit One Per Adult Cash Value 1/20¢

**VALUABLE COUPON**  
S-26  
Pkg. of 6 BORDEN  
**Eskimo Pies** **74¢**  
With Coupon  
Valid at Sentry Through Jan. 31, 1978.  
Limit One Per Adult Cash Value 1/20¢

**VALUABLE COUPON**  
S-30  
On TWO 8 Oz. Bottles  
Assorted HENRI'S  
**Yogurt Dressing** 2 for **89¢**  
With Coupon  
Valid at Sentry Through Jan. 31, 1978.  
Limit One Per Adult Cash Value 1/20¢

**VALUABLE COUPON**  
S-35  
On One Pkg. of 60 Tablets  
or 50 Capsules  
**Extra Strength Tylenol** **\$1<sup>28</sup>**  
With Coupon  
Valid at Sentry Through Jan. 31, 1978.  
Limit One Per Adult Cash Value 1/20¢

**VALUABLE COUPON**  
S-31  
Bonus Pack of 11 GLAD  
**Trash Bags** **\$1**  
With Coupon  
Valid at Sentry Through Jan. 31, 1978.  
Limit One Per Adult Cash Value 1/20¢

**VALUABLE COUPON**  
S-36  
Pkg. of 9 GILLETTE TRAC II  
**Cartridge Blades** **\$1<sup>65</sup>**  
With Coupon  
Valid at Sentry Through Jan. 31, 1978.  
Limit One Per Adult Cash Value 1/20¢



**Kewaskum Statesman**  
250 Main St. Ph. 626-2626

Published Every Friday  
Entered as Second Class  
Matter at the Post Office.  
Kewaskum, Wisconsin 53040

William J. Harbeck &  
Marcella M. Harbeck  
Publishers

Subscription Rates:  
**\$6.00** Per Year in State  
**\$7.00** Per Year Out of State  
Single Copy 15c

Friday, January 27, 1978

active member  
**WISCONSIN**  
**NEWSPAPER**  
**ASSOCIATION**  
MEMBER  
**NATIONAL**  
**NEWSPAPER**  
Association - Founded 1885

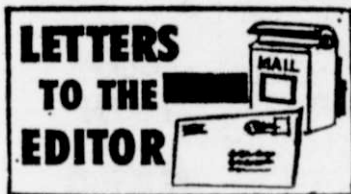

January 17, 1978

Gentlemen:

On behalf of the Washington County Park and Planning Commission, I would like to publicly thank all Washington County Newspapers and all Washington County Banks for the fine cooperation in publishing and collecting the Washington County Land Use Questionnaire. Hopefully, enough of our citizens will let the Commission know, through the questionnaire, what their feelings are on these issues, so that the Commission has a firm grasp of Washington County public opinion to consider when making future Washington County land use and recreation policy decisions and recommendations.

Fred H. Chlupp  
Administrator  
Washington County Land  
Use and Park Department

**The WIGWAM**  
Kewaskum, Wis.  
Phone 626-2901  
Open Daily 11:30 a. m.  
SHORT ORDER MENU  
EXCELLENT DINNERS  
ENTERTAINMENT

Friday, Jan. 27  
NEW LEGION  
ROCK SPECTACULAR

Saturday, Jan. 28  
BANGS

Wednesday, Feb. 1  
NO MUSIC

Friday, Feb. 3  
FLY BY NITE

Saturday, Feb. 4  
AMBER JACK  
Free Beer — 7:30 - 9:30

Page 6  
Kewaskum Statesman  
Friday, January 27, 1978

**Births**

**ALBERT** — A son, Josef John, to Dave and Polly Albert, R. 3, Campbellsport, Wednesday, Jan. 18, at St. Agnes Hospital, Fond du Lac. Paternal grandparents are Mr. and Mrs. Tony M. Albert, Eden. Maternal grandparents are Mr. and Mrs. Joseph J. Mueller, Jr., Campbellsport. Maternal great-grandfather is Joseph J. Mueller, Sr., Campbellsport.

**BEISBIER** — A daughter to Kenneth and Katherine Beisbier, Campbellsport, Wednesday, Jan. 18.

**BREITKREUTZ** — A son to Orville and Susan Breitkreutz, Kewaskum, Saturday, Jan. 21.

**SCHAEFFER** — A daughter to Robert and Anna Schaeffer, Campbellsport, Monday, Jan. 23.

The first potato chips were prepared in 1853 at Moon Lake House Hotel in Saratoga Springs, N.Y. They were made when a diner asked for "thinner than normal French fried potatoes."

**SNOWMOBILE SAFETY CLASS ATTENDED BY 40**

Through the combined efforts of Jack Martin, George Seelig and Bob Staehler, DNR certified instructors with the Kewaskum Sno-Chiefs, another 40 students, from Kewaskum and the surrounding area, were recently certified after the snowmobile safety class held Dec. 3.

Martin and Staehler have each certified over 100 students to date. In recognition of this achievement, they recently received a silver tie pin from the Department of Natural Resources.

**WES & ROSIE'S TAP**

Will Be Open  
All Day Sunday  
Jan. 22, 29 &  
Feb. 5

Kewaskum Sno Chiefs

**Poker Run**

JAN. 20 - FEB. 5  
HAVE A NICE RIDE!

**JORDANS' in kewaskum**

PHONE 626-4618

Open 11:00 Monday - Friday  
Saturday and Sunday 8:00  
Cocktail Hours 4 to 6 p.m.  
HALL AVAILABLE FOR ALL OCCASIONS

FRIDAY, JANUARY 27 — 9-1

**YIPES**  
(FORMERLY RINGS 'N SLICK)



COMING  
SAT. FEB. 4  
9-1  
VIXEN

**LIVE MUSIC**

FRIDAY, JANUARY 27

**BILL THULL'S BIRTHDAY PARTY**

Bill Thull and  
Bob Kuether Orchestra

SATURDAY, JANUARY 28

**NORMIE DOGS ORCHESTRA**

Sponsored by the Boltonville Bunch Snowmobile Club

Large Hall Available for All Occasions

Brat Fry Every Tuesday Night — 50c  
Starting at 6:00 p. m.

**THE AMERAHN**

1/2 mile north of Kewaskum on Hwy. 45

**LIVE MUSIC**  
Every Saturday Nite  
AT  
**WEINREICH'S RECREATION**  
Fillmore  
K 70 17 70  
Never an admission or cover charge  
Saturday, Jan. 28  
**ANNIE and the PLAYBOYS**  
Saturday, Feb. 4  
**SYL VOLM and the POLKA DOTS**  
DON'T MISS OUR DELICIOUS  
Fish and Shrimp Fries  
Every Friday Night  
5:00 TILL 10:30

**SUNDAY BUFFET**

SUNDAY, JANUARY 29, 1978

Featuring: Veal Cordon Bleu on Broccoli Spears with White Wine Sauce, Oven Baked Chicken and Dressing, Roast Pork Tenderloin including our beautiful Sunday Salad Bar and a Dessert.

**4.95**

**Wednesday Specials**

WEDNESDAY NOON, FEB. 1, 1978

Featuring: a cup of Ho-Made Clam Chowder, Turkey ala King over a Ho-made Biscuit, glazed Carrots, Cranberry Salad, a slice of Ho-Made Banana Bread and beverage for

**2.50**

WEDNESDAY EVENING, FEB. 1, 1978

Featuring a Special Diners Delight.  
Barbecue Pork Ribs with our very own special sauce  
This dinner also includes: a cup of soup, choice of potato, our deluxe Lazy Susan, a crisp mixed green salad with your choice of dressing, and a warm loaf of delicious ho-made bread for

**4.95**

CAMELOT IS NOW OPEN MONDAY EVENINGS  
SERVING ALL OF YOUR MENU FAVORITES.

Open Monday's at 4:00 p.m.  
Serving from 4:00 p.m. to 8:00 p.m.

**CAMELOT**  
COUNTRY CLUB

**LIVE ORGAN DINNER MUSIC**

NOON 'TIL 2 P.M.  
and 5 P.M. 'TIL 8 P.M.

Hwy. 67 Just One Mile  
E. of Hwy. 41, Lornira  
Phone 269-4331



# WAREHOUSE SALE!

## Save Hundreds of Dollars!!!

ALL MERCHANDISE WILL BE SOLD AT DRASTICALLY REDUCED PRICES!

JIM LAABS WAREHOUSE SALE IS SPECIALLY LOCATED AT:  
**A. BAER VAN & STORAGE, Inc., 131 Island Street, West Bend, Wisc.**  
(Representing Mayflower Van Lines)

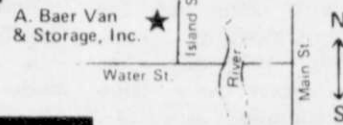

**SPECIAL SALE HOURS: Friday, January 27th, 10-9; Saturday, January 28th, 10-5; & Sunday, January 29th, 1-4.**

JIM LAABS has gathered up new and used musical instruments from his stores across the state and brought them to West Bend for this fantastic sale! This huge selection of name brand musical instruments will be a delight to you and your pocketbook! NEW, MUCH IN CRATES, FLOOR MODELS, DEMONSTRATORS. . . YOU NAME IT & Jim Laabs has gathered it all together for this big sale!!! Savings are tremendous - SO SHOP EARLY WHILE THE SUPPLY IS GREAT!!!

### ORGANS

Choose from a huge selection of Used Organs from . . .

**\$19500!**

Including such brand names as Conn, Wurlitzer, Thomas, Kimball, Hammond, Baldwin, Kinsman, Gulbransen, and Lowrey!

**SAVE \$24500!** on the all new Lowrey Boogie Woogie Teenie Genie with 18 rhythms!

**SAVE UP TO \$90000!**

on other Lowrey Spinet models!

### WIN!!!

A new Model FT120 Epiphone guitar & case valued at. . . **\$13750!**

Entries may be mailed

### CORDOVOX



See the all new CRD-A-2000 Cordovox with automatic rhythm, walking base, complete string section, piano, and much, much more!

#### USED ACCORDIANS

120 Bass, from. . . **\$85.00!**  
 New Cordovox Reduced. . . **\$800.00**  
 Used Cordovox From. . . **\$695.00**

### PIANOS

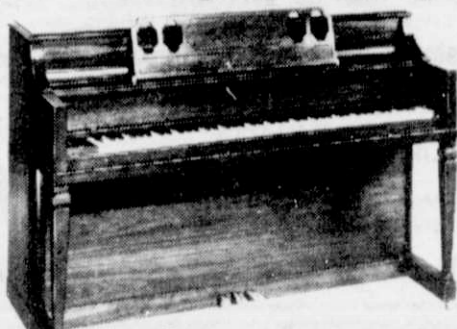

Choose from a complete selection of special buys on pianos!

Story & Clark Provincial, in walnut, Stock No. 60, reg. \$1590. . . . **\$1295.00**  
 Pecan console, Mod. 31. One of the new consoles available at this price. . . **\$895.00**  
 Walnut spinet piano, Mod. 6, contemporary styling, at an affordable price, **\$795.00**  
 Dark Pine Country American console piano, Mod. 82. . . . **\$1470.00**  
 Walnut console, Mod. 91, only 1 of these beautiful pianos left. . . . **\$995.00**

**Plus Many More!**

#### Special Purchase

See the all new Orgatron 4 organ w/automatic chords & magic base. Choose from a large variety of rhythms. With only 2 fingers, you'll be playing your favorite tune in minutes! Complete with bench and music!



While they last. **\$49900**

#### NEW FULL SIZED SPINET ORGAN,

Rhythm & one finger chords. Beautiful walnut cabinet, & easy to play. Reg. \$1095.00.



**Fantastic Sale Price, \$679!**

### AMPS & P.A.'s

ROAD, LAB SERIES, POLYTONE AND KUSTOM!

Plus Many More!!!

NEW & USED

With savings to

**60%!**

### GUITARS

NEW & USED

ACOUSTIC, ELECTRIC, SEMI-ACOUSTIC, AND BASS GUITARS.

CHOOSE FROM Rickenbacker, Gibson, Penco, Epiphone, Alvarez, Guild, Gretsch, Fender, Aspen, Honda, Yamaha, & Lark.

from **\$19.95!**

Save up to

**50%!**



### MOOG SYNTHESIZERS

MINUTE MOOG, Reg. \$895.00. . . Special Price, **\$669.00!**  
 MICRO MOOG, Reg. \$795.00. . . Special Price, **\$579.00!**  
 MINI MOOG, Reg. \$1795.00. . . Special Price, **\$1475.00!**  
 POLY MOOG, Reg. \$4,795.00. . . Special Price, **\$3895.00!**

ALL SYNTHESIZERS REDUCED!

### DRUM SETS

Used Drum Sets from. . . **\$85.**  
 New Drum Sets from. . . **\$175.**

Some new Drum Sets Reduced as much as **\$30000!**

**A ONCE-IN-A-LIFETIME OPPORTUNITY!**

PRICES WILL NEVER BE LOWER!

MANY ITEMS ONE-OF-A-KIND!

1st COME - 1st SERVED!

Guitars, Amps, P.A.'s, Accordians, Cordovox. . . No reasonable offer refused!

Trade-in your present organ - piano or musical instrument and save even more!!!

Pianos & Organs Used for Teaching, SPECIALLY PRICED!

USED INSTRUMENTS OF ALL TYPES AT VERY LOW PRICES!

Take up to 5 years to pay!

Some New Merchandise Slightly Scratched at Give-A-Way Prices!

DELIVER YOUR OWN & SAVE EVEN MORE!

All Drums & Band Inst. to be completely sold as is at unbelievable prices!!!

90 Days same as cash

# Jim Laabs Music

A. BAER VAN & STORAGE, Inc., (Representing Mayflower Van Lines) 131 Island Street, in West Bend, Wisc.





## Cub Scout News

The monthly meeting for Kewaskum Cub Scout Pack 4733 was held on Jan. 23.

The opening flag ceremony was done by the Webelos.

Mark Brodzeller was awarded his arrows - 1 gold, 3 silver.

Mike Coulter became a Bobcat. John Kassekert received his leader Webelos badge.

A balloon relay game was played with some of the father's participating.

On Feb. 12, the Cub Scouts will have their Blue and Gold Banquet. Don't forget to bring your own silverware. Also remember to put your name on your dishes.

Scouts will wear their uniforms to church on Feb. 12. Scouts attending Holy Trinity will go to 9:30 Mass. Scouts

attending Peace United will be present at the 10:15 service.

Each den had their uniform inspection at the meeting.

We are planning on attending the circus on Feb. 25. Cub Scouts families are also welcomed. Check with your den leader.

Also we are in the process of checking to see about a Brewers game for the future.

Closing ceremony was done by the Webelos.

Refreshments were served. On display for the evening Den 6 brought what they made at their den meetings.

## School Menus

### KEWASKUM COMMUNITY SCHOOLS

Menus for week of Jan. 30 - Feb. 3.

Monday — Bar-b-q on bun, potato chips, pork and beans, orange juice and choc. cake.

Tuesday — Meat loaf, baked potatoes, celery, peanut butter, and lemon bars.

Wednesday — Pizza, buttered peas, lemonade drink, jello with fruit and dab of cream.

Thursday — Cubed turkey and gravy on mashed potatoes, waxed beans, cranberries and yellow cake.

Friday — Macaroni and cheese, green beans, choc. nut cups and peaches.

Menus are subject to change. Each meal served with bread, butter and/or margarine and milk.

### HOLY TRINITY SCHOOL

Menus for week of Jan. 30 - Feb. 3.

Feb. 3.

Monday — Turkey sandwich, buttered carrots, cranberries, cookie, milk.

Tuesday — Lasagna, corn bread and butter, O'Henry bar, milk.

Wednesday — Meat loaf, scalloped potatoes, green beans, buttered beets, pudding, milk.

Thursday — Chicken noodle soup, submarine sandwich, cheese slice, lettuce, carrot stix, peanut butter bar, milk.

Friday — Scrambled eggs.

Page 8  
Kewaskum Statesman  
Friday, January 27, 1978

fried potatoes, applesauce, orange juice, cookie, milk.

## J & J AUTO SERVICE

Complete Automotive Service

Air Conditioning Service

Tires

Batteries

Mufflers

Brakes

Major & Minor Engine Repair

Ignition Repair

FREE Pick-up and Delivery in Kewaskum Area

— HOURS —

7:30 to 6:00 WEEKDAYS

CLOSED ON SUNDAY

450 E. MAIN, KEWASKUM  
PHONE 626-2311

## WEST BEND MONUMENT CO.

DIV. OF OZAUKEE MONUMENT WORKS, INC.

208 Island Ave. West Bend, Wis.

- FINEST MATERIALS
- EXPERT WORKMANSHIP
- PERMANENT INSTALLATION
- QUALITY COSTS NO MORE

Monuments of Character



OPEN DAILY 9 to 5; SAT. 9 to 4  
or any time by appointment

Gary Koening Phone Collect 334-3871

## WOOD & Gas or Oil FURNACE

Reduce Heating Fuel Cost up to 75%

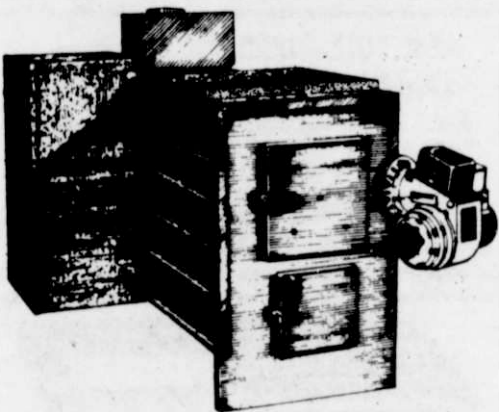

This unique furnace combines the economy of wood with the convenience of gas or oil.

- cuts fuel costs up to 75%
- accommodates wood up to 5 feet long
- provides heat during electric power outages
- requires minimal tending (12-hour intervals)
- ignites wood automatically
- burns wood to fine powder ash
- controls temperature with automatic therm

### LONGWOOD FURNACE CORP.

Builders of the Dualfuel Furnace

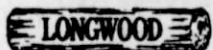

Gallatin, Missouri 64640

Write or Call:

## Johann, Inc.

• Plumbing • Heating • Air Conditioning

### SALES AND SERVICE

located in St. Michaels, 3 miles east of Kewaskum on Hwy. 28

Daily 8 - 5:30; Fri. 'til 9; Sat. 'til 3

334-9481

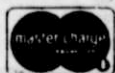

## PERSONALIZED SERVICE & GUARANTEED SATISFACTION

- CARPETING •
- SHINY-VINYL •
- DRAPERIES & RODS •
- FREE ESTIMATES •

— HOURS —

Mon. & Fri. 10 - 9  
Tues., Wed. & Thur. 10 - 5  
Sat. 10 - 3

Or By Appointment

214 MAIN ST.  
KEWASKUM, WIS.  
Phone 626-2181

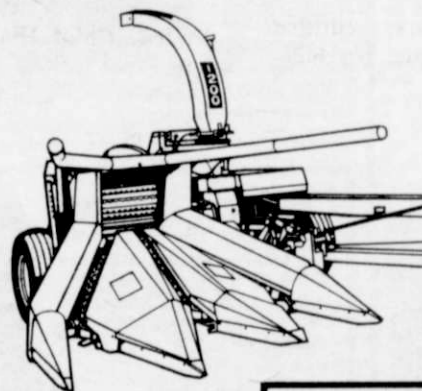

Up to \$225 CASH!

## Early Buyer's Cash Bonus

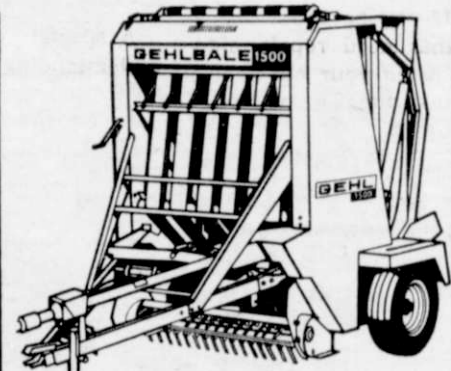

Up to \$180 CASH!



Up to \$80 CASH!

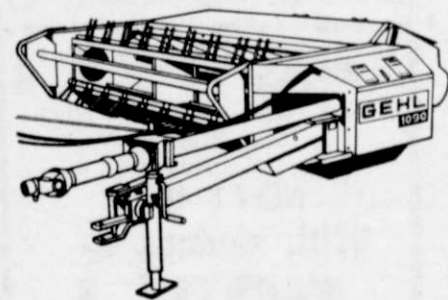

Up to \$125 CASH!

## GEHL® Makes Buying Easier

### BONUS PAYMENT SCHEDULE

Equipment	Model No.	JAN.	FEB.	MAR.
Forage Harvesters	CB700	\$160	\$130	\$100
	CB800	190	150	115
	CB1200	225	175	130
Mower Conditioners	MC770	\$125	\$100	\$ 70
	MC880	125	100	70
	MC1070	125	100	70
Round Balers	RB1500	\$180	\$140	\$100
	RB1500A	180	140	100
Flail Choppers	FC72C	\$ 80	\$ 65	\$ 50
	FB99	80	65	50
	FC630	80	65	50
Self-Unloading Boxes	BU640	80	65	50
	BU920	80	65	50

Now you can get cash back from Gehl with the purchase of eligible forage harvesting and haymaking equipment. See us for full details. (Offer valid on eligible equipment retailed between Dec. 19, 1977 and Mar. 31, 1978)

KOHN BROS.  
Farm Service, Inc.

626-2707



## MPTI Offers Second Semester Classes At Kewaskum High

MPTI has started and will continue to offer second semester classes at the Kewaskum High School. Classes in an area will start as soon as ten people indicate interest and sign up. These courses are held in the area for your convenience.

Courses that have been popular are crocheting, scheduled to start Jan. 23, and antique appreciation which will be followed in early spring with a follow-up course that will include field trips to places of interest to those involved in antiques.

Basic art and ceramics will be conducted by John Baitinger.

Basic life support and first aid courses are being conducted at the Beechwood School.

Beverage host is geared for those who would like to work as bartenders but it is also helpful for those who want to mix drinks and entertain at home.

Cake decorating has been very popular and Arnold Stommel will again teach the course. Stommel is very qualified in the art of cake decorating and presents a very interesting class.

Joe Ledington teaches the techniques of chair caning and we are looking for a few more to sign up so we can start. If you have old cane chairs that need repair, sign up and bring your old chairs in and take them home looking like new.

Computer programming is a course that will present a very basic background in the use of computers.

Crewel embroidery has been popular in past years along with decorative eggs, but we have not had enough sign up so far this year. These classes offer you a chance to have beautiful decorations for your home.

Defensive driving is valuable for all those who drive but it is especially useful to senior citizens for many insurance companies have given incentives for those who take the course.

We plan to start the diet delight course soon. We hope those who plan to take a few pounds off sign up soon so we can get started.

If we have enough interested in sewing and clothing we will set up the course to meet the needs of those signing up.

Flowers in the home and



TOP CASH - GLOVES  
FOR DISABLED OR DEAD  
COWS OR HORSES  
NO CHARGE FOR DEAD  
CALVES OR PIGS  
When Picked up in Area  
Phone Collect Oshkosh 233-1010  
**NELSON FARM  
SERVICE**

plants in the home and yard can be very enjoyable courses for those interested in this area.

Furniture refinishing will start in the near future but there is still room for interested persons.

Gourmet cooking is an interesting course and we hope those not signed up for diet delight will sign up for this course.

We haven't been able to get enough people signed up for knitting this year but as soon as there are a few more interested we will start the course.

Rosemaling, rug hooking and braiding will again be offered. We are ready to start the basic shorthand course and will also start the typing course as soon as we have 2 or 3 more people sign up.

We are ready to start the small engine course but need two more students.

Supervisory training and tax preparation are short of the 10 people needed before we can start.

The upholstery course is nearly filled but we maintain a waiting list and get everyone in as openings occur.

We are also interested in a basic welding class if we generate enough interest.

The popular woodworking course is nearly filled but as in upholstery and some other courses, we maintain a waiting list.

A special course entitled understanding the psychological needs of the aged will be offered Feb. 7 and finish on Feb. 14.

For more information on these courses or if you are interested in other courses, call 626-2166 to contact the center supervisor, Roy Esser.

### Minutes of Village Board Meeting

Regular Meeting  
January 3, 1978  
8:00 P. M.

The Village Board of the Village of Kewaskum, Washington County, Wisconsin, met in regular monthly session in the Council Room of the Municipal Building.

President Charles Miller presided. Present were Trustees G. Nigh, Herriges, Schmidt and D. Nigh. Trustees Daniels and Kral were absent and had asked to be excused.

One correction was noted to the minutes of December

CASH "OLE CROW" CASH



**ANIMAL SERVICE**  
CASH or GLOVES  
For Dead and  
Down Stock  
DIAL TOLL FREE  
1-800-242-0389  
1-800-242-0343  
Prompt 3 Hour Service  
UP TO 6c A LB.  
for live horses over 900 lbs.  
as market allows.

20th. The Federal Revenue Sharing funds for the fiscal year 1978 will be expended as follows: 85% for public safety and 15% for recreation. Motion by Trustee Schmidt, seconded by Trustee Herriges. Unanimous vote. In all other respects, the minutes were approved as printed.

Motion was made by Trustee Schmidt and seconded by Trustee Herriges that the wording in the fourth last paragraph of the minutes of the meeting of November 21 be clarified by changing "effective as of the first pay period in December" to "effective after the first pay period in December." Unanimous vote.

At this point motion was made by Trustee G. Nigh, seconded by Trustee Herriges and unanimously carried that the Board recess to closed session to discuss with the officials of the Town of Kewaskum the terms of the fire service contract for the year 1978 between the Village of Kewaskum and the Town of Kewaskum.

The Village Board reconvened in official session at 8:50 p. m.

An easement to install an underground electrical lateral to the bathhouse in the Kewaskum Kiwanis Community Park was granted to the Wisconsin Electric Power Co. upon motion by Trustee G. Nigh, seconded by Trustee Herriges. Trustee Dan Schmidt abstained from voting on the motion.

Roll call vote - 3 Aye  
0 Nay

Police Chief Hlavaty was granted permission to solicit sealed proposals for the purchase of a new police car. Mo-

### For Wonderful Springtime Comfort, The Year Around



### NOW-INTERTHERM Electric HOT WATER HEAT AND AIR CONDITIONING WITHOUT PLUMBING

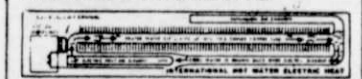

WATER AND ANTI-FREEZE SEALED-IN PERMANENTLY...NEVER NEEDS REFILLING. INSTALLED PERMANENTLY FOR ENTIRE HOMES, APARTMENTS, ETC.

**HEALTHIEST**—Circulating hot water gives you the kind of controlled all-over warmth many doctors choose for their own homes, as well as prescribe for their allergic patients, without the contamination and dry, parched air that other methods of heating give, and without dust or dirt blowing around.

**SAFEST**—Place your flimsiest drapes right over the heater without the slightest danger. More important, children and pets can't be burned.

**ECONOMICAL**—You get balanced, steady warmth even when current is turned off. After thermostat turns off electric element, circulating hot water continues to circulate heat for comfortable warmth.

### JOHANN, INC.

- Plumbing • Heating
- Air Conditioning
- Sales & Service

Located in St. Michaels, 3 miles east of Kewaskum on Hwy. 28  
Daily 8-5:30; Fri. 'til 9; Sat. 'til 1

PHONE  
334-9481

tion by Trustee Schmidt, seconded by Trustee D. Nigh. Unanimous vote.

The Commissioner was instructed to obtain an estimate from the Lane Tank Company of Menomonee, Wisconsin, for the installation of a new overflow pipe on the water tower as required by the Wisconsin Department of Natural Resources. Motion by Trustee Herriges, seconded by Trustee Schmidt. Unanimous vote.

The proposal of Roger's Service for the recapping of four (4) truck tires was accepted by the Board upon motion by Trustee Herriges, seconded by Trustee D. Nigh. Unanimous vote.

The proposal for the purchase of a used street sweeper was tabled. Motion by Trustee G. Nigh, seconded by Trustee Schmidt. Unanimous vote.

The proposal for the adjusting of the village's license and permit fees was tabled. Motion by Trustee Schmidt, seconded by Trustee G. Nigh. Unanimous vote.

Trustee Schmidt, Chairman of the Park Development Committee, reported that he had been notified by the Wis-

consin Department of Natural Resources that the village's application for park funding for the year 1978 had been received by their district office.

The Board discussed the possibility of making an ice skating rink.

The totals of all claims, as recommended for approval by the Finance Committee, were as follows:

Village Gen. Fund \$31,317.45  
Water Dept. Fund 779.68  
Sewage Dept. Fund 2,801.94

Motion was made by Trustee D. Nigh, seconded by Trustee G. Nigh to approve for payment all bills as presented by the Finance Committee. Roll call vote was unanimous.

Upon motion by Trustee G. Nigh, seconded by Trustee Schmidt and unanimously carried, the Board adjourned to 8:00 p. m. January 16, 1978.

William S. Martin,  
Commissioner



One carton  
covers 6 sq. ft.  
REG. \$6.99

**\$4.54**  
CARTON  
Cash & Carry

A few reasons why more people buy Z-BRICK than any other product of its kind.

**FIREPROOF**—Z-BRICK is completely non-combustible, will not burn, melt, expand or explode. Carries Underwriter's Laboratory label.

**WEATHERPROOF**—Z-BRICK is unaffected by indefinite exposure to rain, sun, cold or heat. Use outdoors anywhere.

**PERMANENT**—Z-BRICK is as durable as any material you can use in your home. Never needs refinishing.

**TAKES ABUSE**—Z-BRICK is tough and durable. Withstands impact and hard service. A truly low-maintenance surface.

**ECONOMICAL**—Z-BRICK, in spite of all its advantages, is less expensive than most other brick wall coverings.

**GOES UP EASILY**—Z-BRICK goes up in a simple 1, 2, 3 manner. You don't have to buy corners, or caulking tubes, or starter strips, or make a double application of adhesive.

Reserve one wall in your home for Z-BRICK

Choose from White, Old Chicago  
and "Used"



Hwy. 45 S. of West Bend 128 Main St.  
Kewaskum  
Phone: 334-4044 or 334-9611 Phone 626-2164



# WANT ADS

**FOR RENT**—One bedroom upper flat. Call 626-2473. 1-27-tf

**FOR SALE**—GE gas clothes dryer. Good condition. Call 533-4054 after 5:00 p. m. 1-27-2p

**WANTED TO BUY**—Standing timber, with or without land. Call or write us for offers. **ALGOMA LUMBER COMPANY**, Algoma, Wis. 54201. Phone 414-487-3511. 1-27-6

**FOR RENT**—One bedroom lower apartment in Kewaskum. Adults preferred. Available Feb. 1. Phone 626-2568. 1-20-tf

**FOR RENT**—Duplex. 1½ miles out of Kewaskum. Gas heat, refrigerator. Available Feb. 1. 626-2663. 1-20-2p

**WILL DO CHILD CARE**—In my home. Days or evenings. Playmate for my 3-year-old. 626-4012. 20-2t

**FOR RENT**—Lovely 2 bedroom apartment in Kewaskum. Shag carpet throughout with appliances. \$170 plus security deposit. Ph. 626-4735. 8-12-tf

**HELP WANTED**—Experienced meat cutter, part-time, mornings. Apply in person. Sentry Foods, Kewaskum. 626-2630. 1-20-2t

**POTATOES**—Call 626-2251 after 5:00 p. m. 1-6-4p

**HELP WANTED**—Secretary, Law Office. Full-time position. Typing and shorthand required. Small office with excellent working conditions. Send resume and salary requirements to P. O. Box 98, Kewaskum. 11-25-tf

**SNOWPLOWING**—Country Aire Repair. Phone 626-2717 or 626-4345. 12-23-tf

**FOR RENT**  
Retail store, could be used for many types of business. Main street location. Will remodel to suit tenant. This store has parking in front and back. Large front windows to display merchandise. Village of Kewaskum.  
Call Owner  
**KEWASKUM REALTY**  
Kewaskum, Wis. 53040  
626-4392

**FOR SALE**  
350 Lazy Lane, Kewaskum, is the address of this lovely 3 bedroom home. Well insulated. Well built by a very good West Bend builder. 2 car garage, 70 x 150 ft. lot. This home is complete with floor covering and decorating included.  
**KEWASKUM REALTY**  
Kewaskum, Wis. 53040  
Phone 338-8500

**WANTED**—Newcomers to the village of Kewaskum. The "Kewaskum Welcomes You" committee would like you to call 626-4732 or 626-4219. 5-13

**POTATOES**—Call Paul Pamperin, 629-5267. 11-11-tf

**OFFICE OR STORAGE SPACE**—Available in Kewaskum. Phone Kewaskum Savings, 626-2186. 11-11-tf

**TIRES**—Get your snow tire deal at Roger's Service. Radial snows in stock. Hwy 45 south, Kewaskum. Ph. 626-2888. 10-7-tf

**SERVICES OFFERED**—All landscaping services and supplies. Call Schultz's Greenhouse now in Kewaskum, 626-2432. 9-16-tf

**SERVICES OFFERED**—Snowplowing, jumping cars and trucks, etc. 24-hr. service. 626-4618. 12-16-tf

**SERVICES OFFERED**—Small engines, motorcycle, snowmobile, lawn and garden equipment and outboard repair. Ked-Web of Kewaskum, 1204 Fond du Lac Ave. Phone 626-4344. tf

**SERVICES OFFERED**—Perce tests - septic systems installed - swimming pools - field tiling. Schwartz Trenching. Phone Arnold Kutz 334-5004 or Gary Schwartz 994-4535. tf

**COMPLETE wild bird supplies** at Schultz's Greenhouse, Kewaskum. 10-7-tf

**HIGHEST PRICES** paid for old newspapers, copper, brass, aluminum, lead and batteries. Lynn's Waste Paper Co., 121 Island Ave., West Bend, Wis. tf

**LEN LUTERBACH CONTRACTOR**—Mason, cement, carpentry, trenching and bulldozing. Quality work at competitive prices. For free estimate, call 338-3305 or 692-9233 collect. tf

Give a gift subscription to the Statesman.

**"For all of your Real Estate Buying or Selling needs (homes, farms, vacant land, commercial, investment),**

**call BOB TISCHENDORF**  
533-8557

**LARRY SWENSON REALTY**  
1702 West Washington St., Hwy. 33  
West Bend, WI 53095 Phone 1-414-338-6681

**BUY and SELL with**  
**BOWE & WENINGER REALTY, INC.**  
West Bend 334-7841  
Norbert Rohlinger, Broker - Sales — Phone 626-2332  
**ACTION + SATISFACTION**

## CARD OF THANKS

We wish to thank all our relatives, friends and neighbors for their kind expression of sympathy in the death of my beloved husband and our dear father, grandfather and great-grandfather, **PETER KOHLER**. Special thanks to Frs. Budde and Waldkirch, nurses and nurses aides on the third floor at the Samaritan Home, donors of Masses, floral pieces, food, organist, choir, Miller's Funeral Home, police officer and to all who showed their respect in any way.

Mrs. Peter Kohler  
Mr. and Mrs. Allen Dreher and family  
Mr. and Mrs. Frank Kutz and family  
Mr. and Mrs. Paul Kohler and family

## CARD OF THANKS

We wish to thank all our relatives, friends and neighbors for their kind expression of sympathy in the death of my beloved wife, our dear mother and grandmother, **HELEN WESTERMAN**. Special thanks to the Kewaskum Rescue Squad, Fr. Budde, donors of spiritual and floral pieces, organist, choir, Miller's Funeral Home, police officers and to all who showed their respect in any way.

Walter Westerman and Family

## A NOTE OF THANKS

I wish to extend my thanks to all my relatives, neighbors and friends for all the prayers, cards, gifts, visits and phone calls while I was a patient at the hospital. Special thanks to Rev. Stuebs and to the doctors and nurses at Plymouth Hospital and Deaconess Hospital. These many acts of kindness are deeply appreciated and will long be remembered.

Jerome Schmidt

## THANKS EXPRESSED

I wish to extend my thanks to all my relatives and friends who remembered me with cards, gifts, visits and phone calls while I was a patient at the hospital and convalescing at home. Your kindness was deeply appreciated.

John Felten

## DUPLEX FOR SALE

To be salvaged or moved from present lot in Kewaskum. Available for inspection at Fairmont Foods, Kewaskum, Wis. Phone 626-2141

## LISTINGS NEEDED

CALL FOR MARKET ESTIMATE.

## J-N REALTY

Jerry Nigh, Broker  
626-4063

## Under Construction

## 2 RANCH HOMES

3-bedroom

on 1-acre lots

in the

Town of Wayne

Feb. 1 Occupancy

**H. F. K. Ltd. Builders**

For Showing Call  
David (Norby) Amerling  
626-2320

## Notice of Public Hearing

Public notice is hereby given that the Village Board of the Village of Kewaskum, Washington County, Wisconsin, will hold a public hearing on the following proposed ordinance which deals with the adjusting of the village's license and permit fees.

The public hearing is scheduled for Monday evening, February 6, 1978, at 8:00 o'clock P. M. in the Council Room of the Municipal Building, 204 First Street.

William Martin, Clerk

**AN ORDINANCE TO REPEAL AND RECREATE SECTIONS 12.01 (7), (8) and (9) OF THE MUNICIPAL CODE OF KEWASKUM, WISCONSIN, AND TO CREATE SECTIONS 12.01 (12) and 12.01 (13) OF THE MUNICIPAL CODE OF KEWASKUM, WISCONSIN, RELATING TO LICENSE AND PERMIT FEES.**

**THE VILLAGE BOARD OF THE VILLAGE OF KEWASKUM, WASHINGTON COUNTY, WISCONSIN, DO ORDAIN AS FOLLOWS:**

**Section 1.** Section 12.01 (7) of the Municipal Code of Kewaskum, Wisconsin, is repealed and recreated to read as follows:

(7) **DANCE PERMIT.** \$25.00 per dance.

**Section 2.** Section 12.01 (8) of the Municipal Code of Kewaskum, Wisconsin, is repealed and recreated to read as follows:

(8) **FERMENTED MALT BEVERAGES.**

- (a) Class "A" Retailer's License. \$10.00 per year.
- (b) Class "B" Retailer's License. \$100.00.
- (c) Picnic License (special events). \$1.00 per day.
- (d) Wholesaler's License. \$25.00.
- (e) Operator's License. \$5.00.
- (f) Duplicate License. \$5.00 per license.
- (g) Transfer. \$10.00 per transfer.

**Section 3.** Section 12.01 (9) of the Municipal Code of Kewaskum, Wisconsin, is repealed and recreated to read as follows:

(9) **INTOXICATING LIQUOR LICENSE.**

- (a) Class "A" License. \$150.00.
- (b) Class "B" License. \$200.00.
- (c) Pharmacist's Permit. \$10.00.
- (d) Operator's License. \$5.00.
- (e) Duplicate License. \$5.00 per license.
- (f) Transfer. \$10.00 per transfer.

**Section 4.** Section 12.01 (12) of the Municipal Code of Kewaskum, Wisconsin, is created to read as follows:

(12) **SPECIAL ASSESSMENT CERTIFICATE.** \$2.00 per certificate.

**Section 5.** Section 12.01 (13) of the Municipal Code of Kewaskum, Wisconsin, is created to read as follows:

(13) **PARK USE FEE - KITCHEN FACILITIES.** \$25.00 per day, \$10.00 to be refunded if facilities are properly cleaned up.



**NOTICE**

**TOWN OF KEWASKUM RESIDENTS**

Ordinances pertaining to mobile homes, subdivisions, and driveway access/culverts will be adopted by the Town Board Wednesday, Feb. 15, 1978, 7:30 p. m., at the Town Garage, 9340 Hwy. 45, Kewaskum.

First Reading January 18, 1978.

Copies available from Town Clerk, 9055 Kettle Moraine Drive, Kewaskum, after Feb. 1, 1978.

Dated this 21st day of January, 1978.

Barbara Hinz, Town Clerk

**PUBLIC NOTICE**

Public notice is hereby given that the next meeting of the Village of Kewaskum, Wisconsin, Plan Commission is scheduled for Tuesday evening, January 31, 1978, at 7:30 P. M. in the Council Room of the Municipal Building, 204 First Street.

William Martin,  
Recording Sec'y.

SIGN on a garbage truck: "Used food purveyors."

**LIGHTHOUSE SIX**

	Won	Lost
West Bend Co.	81	52
Hitching Post	73	60
Herriges Oil	71	62
Herriges Tap	63	70
Russ Breit Sales	56	77
Barton Const.	55	78

**Veterinary Services**  
LARGE & SMALL ANIMALS  
WOODVIEW  
VETERINARY CLINIC  
Drs. Bushard & Thornborrow  
North Point Shopping Center  
Hwy. 45 N. of West Bend  
Phone 338-1838

**BUILT TIGHT FOR TOTAL ENERGY PERFORMANCE.**



Welcome Home.  
**KEWASKUM REALTY**  
333 Main St., Kewaskum, Wis.  
338-8500

**DUNDEE Sand & Gravel**

G. Ramthum Ph. 533-4549  
Washed Sand, Crushed Gravel, Stone and Lime Chips also, GRAVEL and SAND FILL FOR THE BEST OF CONCRETE MATERIALS

**KEYS**  
MADE IN ONE MINUTE  
BUY AN EXTRA KEY  
**Honeck Chevrolet**  
KEWASKUM

**ROGER'S SERVICE**



Your Automotive Needs With Many Years Experience

Major Tune-ups  
Brakes & Mufflers

ELECTRICAL SYSTEMS

Carburetor Overhauls

SHOCKS, TIRES & BATTERIES

24 Hr. Wrecker Service

8745 Hwy. 45 So. KEWASKUM

626-2888

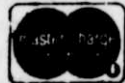

**APPLES FOR SALE**

At the Bridge in Kewaskum  
Every Saturday 10 a. m. til Noon  
Cortland — McIntosh — Delicious  
Secors — Fresh Cider  
**CHERRY HILL FARM**  
BATAVIA, WI.

**THE SUPER MARKET OF AUTO REPAIRS**

**Goeden Auto Body**

Complete Auto Body Repairs and Painting Professionally Done

INSURANCE ESTIMATES AND REPAIRS OUR SPECIALTY

Automotive - Tune-Ups - Exhaust - Brakes  
Tires - Anti-Freeze - Texaco Products  
ALL DONE TO YOUR SATISFACTION  
24 HOUR TOWING  
Hy. 28 E. of Kewaskum in St. Michaels  
334-2759

Try Our Personalized Service

**HONECK HAS A CAR JUST FOR YOU!**

1977 Chevrolet Nova, 4 door, V8, automatic, air conditioning, only 8,000 miles.

1977 Chevrolet Monza Town Coupe. 4 cylinder, 4 speed, Cabriolet roof.

1977 Pontiac Ventura 4 door. V6 engine, automatic. Only 5,000 miles.

1975 Chevrolet Malibu 4 door. V8, automatic. Only 24,000 miles.

1975 Plymouth Duster. 360-V8, automatic transmission, 22,000 miles.

1975 Plymouth Fury Custom Coupe. V8 engine, automatic, 22,000 miles.

1975 Buick Special Coupe. V8 engine, automatic, 36,000 miles.

1974 Chevrolet Corvette. 350-V8, automatic, 50,000 miles. SHARP!

1974 Chevrolet Impala. 4 Door, V8, automatic, 31,000 miles.

1976 Chevrolet Caprice Coupe. V8, automatic, 23,000 miles.

1974 Chevrolet Camaro. V8 engine, 3 speed, 41,000 miles.

1974 Chevrolet Camaro LT. V8, automatic transmission, 50,000 miles.

1973 Chevrolet Impala Sport Sedan. 350-V8, automatic, 63,000 miles.

1973 Chevrolet Impala stationwagon. 350-V8, automatic, 2 seater.

1973 Chevrolet Impala. 4 door, 350-V8, automatic. Only 42,000 miles. CLEAN!

1975 Ford Torino, 4 door sedan, V8, automatic, 34,000 miles.

1975 Audi Fox 4 door sedan, 4 cylinder, automatic, 23,000 miles.

1975 Chevrolet Impala 4 door, 350 V8, automatic, air conditioning, 43,000 miles.

1975 Chevrolet Chevelle Malibu coupe, V8, 350, automatic, air conditioning.

1974 Chevrolet Vega hatchback coupe, 4 cylinder engine, 4 speed.

1974 Vega station wagon, 4 cylinder, automatic, priced right.

1974 Chevrolet Impala 4 door, 350 V8 engine, automatic, 30,000 miles.

1976 Ford Gran Torino station wagon, 351 V8, automatic, air, 12,000 miles.

1973 Chevrolet Impala 4 door, 350 V8, automatic, 52,000 miles.

1973 Chevrolet Impala coupe, V8, automatic, vinyl roof, only 33,000 miles.

1973 Monte Carlo coupe, V8 engine, automatic, 46,000 miles.

1973 Buick Electra V8, automatic, air, loaded, 45,000 miles.

1973 Chevrolet Impala coupe, V8, automatic, 50,000 miles.

MANY OLDER USED CARS

"A Dealer You Can Trust"

**HONECK CHEVROLET**

Hwy. 45 Kewaskum, Wis. 53040  
Phone 626 2161

Open Mon. thru Fri. 9 to 9 Sat. 9 to 5

Uncle Ray Says:

SOME PEOPLE, LIKE BLOTTERS, SOAK IT ALL IN BUT GET IT ALL BACKWARDS!



Whether our fuel oil flows into your burner forwards or backwards, it will burn clean and hot to assure your comfort. Call HERRIGES OIL, INC., phone 626-2244, for prompt fuel oil delivery.



626-2244

KEWASKUM

Meet the Men of

**AUTO CRAFT**



Dan Berres, Owner  
West Bend



Tom Vvaters  
West Bend



Lynn Voigt  
Campbellsport



Pete Dalton  
West Bend



Pat McIntee  
Slinger

These trained men are dedicated to building a business on professional work, fast service and friendliness that you as our customer deserve. This is why we proudly say:

**PICK YOUR BODY SHOP BEFORE WE MEET BY ACCIDENT**

Take Hwy. 45 south of Kewaskum four miles to Trap Shoot Lane.

(road to West Bend Sportsmen's Club)  
or call 338-0379





# SPORTS

## Indians Nip Germantown for 2nd Win; Defeated by Leading Lasers

The Kewaskum Indians nipped Germantown here Friday night, 51-50, for their second win against five defeats and moved ahead of the Warhawks in the standings.

The Indians had the opportunity to put Germantown away in the first half when they gained an 11-point lead near the end of the second quarter. They were led by Roger Rezel, who had a good half of basketball both in rebounding and shooting. Two quick buckets by the Warhawks narrowed the gap to 7 at the intermission.

The Indians held onto their lead throughout the third quarter but Germantown came to within one point of tying it up by outscoring them, 14-8. Kewaskum stayed ahead, most of the time by several points, until the Warhawks made it 51-49 with 38 seconds left in the game. A free throw closed the gap to one point. Germantown got in three shots in the last 10 seconds but missed them all as the Indians won a squeaker.

Mark Tessar was high scorer with 15 points, 7 of them in the final quarter. He also made some excellent passes which resulted in easy baskets. Al Jaeger was next with 12 and Rezel had 11. Doug Wagen led Germantown with 13 and John Schultz 12.

In other Friday games, leading Hartland was upset by Mayville, 61-50, Kettle Moraine moved into a tie for first by nipping Grafton, 56-52, and winless Pewaukee upset Slinger, 78-74.

Kewaskum made a clean sweep of it as the JV's beat Germantown, 62-52, and the frosh won, 34-31. Henry Schilfer scored 20 and Al Dominguez 18 for the JV's.

GERMANTOWN	lg	ft	ft	Kewaskum	lg	ft	ft
Wagen	4	5	2	Kern	3	0	0
Schultz	5	2	4	Jaeger	5	2	3
Hakes	2	1	2	Paling	1	2	5
Vance	2	1	3	Tessar	6	3	2
Lutz	1	0	1	Rezel	3	5	2
Powell	0	0	0	Perkins	1	1	2
Hall	0	0	0	Motenoer	0	0	0
Nolter	1	0	0	Rabuck	0	0	0
Heiser	3	0	1	Steinhardt	0	0	0
Keller	2	1	1	Totals	19	13	14
Schmelzer	0	0	2				
Totals	20	10	16				

GERMANTOWN 11, 15 14, 10-50  
Kewaskum 14, 19 8, 10-51  
Free throws missed - Germantown 7, Kewaskum 9

Playing at Kettle Moraine Tuesday, the Indians surprised the leading Lasers by taking a 3-point, 26-23 half-time lead. But Kettle came back like gang busters in the third quarter, scoring 25 points to Kewaskum's 6, and rolled to a 68-51 victory.

The win gave the Lasers sole possession of first place as lowly Slinger upset Hartland, which lost its last two games after having been previously undefeated. The loss dropped Kewaskum to a tie for sixth with Germantown, both 2-6.

Kettle didn't look anything like a first place team in the first half as the Indians, switching defenses, forced them into poor shots and many

turnovers. But they looked like a different team in the second half as Todd Khempasky and Mike Fink became a deadly duo in scoring as well as in assists and steals.

At one point the Lasers scored 13 unanswered points and then after two Mark Tessar free throws, added six more in a row. The Indians had only 14 baskets, five of them by Tessar, who added 12 of 13 free throws for 22 points and scoring honors. Fink got 20 and Krempasky 16 for the winners.

Besides Slinger's upset over Hartland Tuesday, 70-64, Grafton beat Mayville, 70-56, and Germantown routed Pewaukee, 72-57.

This Friday Kewaskum plays at Mayville (5-3).

Kewaskum	lg	ft	ft	Kettle Moraine	lg	ft	ft
Jaeger	1	6	2	Denk	2	0	3
Tessar	5	12	2	Krempasky	8	0	5
Paling	4	1	2	Ruffing	3	4	1
Kern	1	3	4	Fink	9	2	4
Perkins	0	1	2	Rhyner	3	0	5
Rabuck	1	0	2	Belart	3	0	3
Motenoer	1	0	2	Circuits	2	0	2
Hillmer	1	0	1	Hillmer	1	0	2
Curran	0	1	0	Curran	0	0	2
Dominguez	0	1	0				
Totals	14	23	17		31	6	27

Kettle Moraine 12, 11 25, 20-66  
Kewaskum 14, 12 6, 19-51  
FT Missed - Kewaskum 12, Kettle 8

### Scenic Moraine Standings

Team	W	L
Kettle Moraine	7	1
Hartland	6	2
Grafton	6	2
Mayville	5	3
Slinger	5	5
Kewaskum	2	6
Germantown	2	6
Pewaukee	1	7

## Indian Wrestlers Stun Random Lake

The Kewaskum matmen came up with a big win Tuesday night against a tough Random Lake squad, 22-20. It was the first time in years the Indians got by the Rams in wrestling for their third win against seven losses.

Kewaskum had to give up its usual 6 points for forfeiting at unlimited. Dan Schmidt at 145, who had been injured, won 6-2. Cliff Wilson dominated Randy Haas, 12-0, at 132, and Mark Strigenz, 138, in one of his best matches, was an 8-2 winner over Wayne Kleckner. Another big win was at 98 lbs. where frosh Scott Klein won 3-0 in his first varsity bout. Other winners were Mike Ruplinger at 112 and Jay Jansen at 167.

- Kewaskum 22, Random Lake 20
- 98 - Scott Klein dec. Russ Miller 3-0
- 105 - Jeff Gundrum lost to Ron Theis 8-2
- 112 - Mike Ruplinger dec. Lonnie Fernandez 5-2
- 119 - Tom O'Reilly lost to Lee Jacoby 4-0
- 126 - Rob Secor lost to John Hammen 3-1
- 132 - Cliff Wilson dec. Randy Haas 12-0
- 138 - Mark Strigenz dec. Wayne Kleckner 8-2
- 145 - Dan Schmidt dec. Jeff Ternes 6-2
- 155 - Steve Schneider drew with Tim Walber 2-2
- 167 - Jay Jansen dec. Ron Gonwa 6-2
- 185 - Scott Hayes lost to Dave Janik 4-0
- Unl. - KHS forfeits to Random

## Eichstedt Scores 46 in Lakes Win Over West Bend

Ken Loest hit on four free throws in the last seven seconds to seal Kewaskum's 142-138 win over West Bend there Sunday night in the Land o' Lakes.

Trailing throughout, West Bend never gave up and nearly erased an 11-point deficit in the last quarter. Its 39-32 advantage in the last period saw Mitch Knox, Mike Hughes, Pete Thomas and Bill Schaefer score 10, 9, and 8 points. In the same frame Dennis Pieper poured in 12 of his 27 for the winners.

Kewaskum, tied for second with 4-3 in the "B" Division, needed good free throw shooting to win. They hit on 18 of 22 for 81.8 per cent, while West Bend made 10 of 13 for 76.9. The losers had two more field goals.

Clark Eichstedt poured in 46 points for Kewaskum to lead all scorers, while Knox whipped in 43 for West Bend. "Ike" scored 18 of his points during Kewaskum's most decisive second quarter.

Kewaskum will host leading Thiensville - Mequon in a key game Saturday at 7:30 p. m.

Kewaskum	lg	ft	ft	West Bend	lg	ft	ft
Loest, Ken	3	5	3	Knox, Mitch	20	3	4
Zach, Tom	12	3	5	Rondorf, Chuck	4	0	5
Bichtedt, C.	21	4	5	Thomas, Pete	9	2	3
Bockhaus, Bill	2	1	1	Young, Lee	1	0	2
Pieper, Dennis	11	5	4	Hughes, Mike	10	1	3
Leider, Rich	5	0	1	Gonwa, Bill	2	0	1
Weddig, Steve	1	0	3	Zittel, Tim	6	2	2
Winkler, Tom	0	0	0	Schaefer, Bill	10	2	1
Stuffel, Doug	1	0	1	Schaefer, Bill	10	2	1
Totals	62	18	23	Totals	64	10	25

Kewaskum 35 34 41 32-142  
West Bend 36 25 38 39-138  
FTM - Kewaskum 4, West Bend 3

LAND O' LAKES BASKETBALL  
Jan. 21 - Hartford 122 at Slinger 93; Sussex 121, at Cedarburg 106.  
Jan. 22 - Oconomowoc 125 at M. Falls Badgers 155; Port Washington 102 at Thiensville-Mequon 130; Kewaskum 142 at West Bend 138.

THE STANDINGS  
A DIV. W L B DIV. W L  
Slingers 6 1 T-Mequon 5 1  
Badgers 5 1 Hartford 4 3  
Sussex 4 2 Kewaskum 4 3  
Ocono. 3 4 Port Wash. 2 4  
Cedarburg 0 5 West Bend 1 5  
Slinger 1 6

Schedule:  
Jan. 28 - Thiensville-Mequon at Kewaskum; Slinger at Port Washington.  
Jan. 29 - Oconomowoc at Cedarburg; Thiensville-Mequon at M. Falls Badgers; M. Falls Slingers at Sussex; West Bend at Hartford.

## Kewaskum Girls Tip Germantown

The Kewaskum girls' basketball team defeated Germantown Thursday night, 45-33, on a fine defensive effort on the Warhawks' home floor. They held Germantown to just one basket in the first half, while taking a 26-9 lead.

Janine Prost scored 11 points, followed by Mary Ryan with 9, Yvonne Schacht 8, and soph guards Janet Matenaer and Bobbi Schmidt 5 each. Prost was also tough on the boards and Ryan had perhaps her best game with a couple blocked shots and several steals.

Germantown's Debbie Hart took game honors with 13 points. Kris Kuells was next with 7.

The Warhawks were 3-1 and tied for second place going into the game. Kewaskum is now 2-4.

Kewaskum 11 15 6 13-45  
Germantown 4 5 8 16-33

## KEWASKUM RECREATION BASKETBALL LEAGUE

Scores Jan. 19 - Amerahn 76, Pine Inn 50; Three R's 70, Bartelt's 47; Trio Bar 68, Wigwam 59.

High scorers - Amerahn, Rondorf 26; Pine Inn, Darmody 15; Three R's, Rohlinger 17; Bartelt's, Boegel 16; Trio Bar, Long 18; Wigwam, Backhaus 20.

Thursday, Jan. 26, games and times: 7:00 - Bartelt's vs. Trio Bar; 8:00 - Three R's vs. Amerahn; 9:00 - Wigwam vs. Pine Inn.

Did you hear about the pro basketball player who was so rich he had an unlisted number on his jersey?

Leading scoring average - Chuck Boegel, 27 points per game.

Coach of the week - Once again Tom Bartelt.

### STANDINGS

Team	Won	Lost
Three R's	4	0
Amerahn	3	1
Trio Bar	3	1
Bartelt's	2	2
Wigwam	0	4
Pine Inn	0	4

### WED. MORNINGETTES

Paula Kutz, Sec.  
Jan. 18, 1978

Team	Won	Lost
Herriges Tap	87	46
Everglades	81	52
Serve's Tap	75	58
Behring's Market	68	65
King Pin Lanes	60½	72½
Weis Tavern	55½	77½
Silver Key	54	79
Nass Upholstery	51	82

Indv. High Series: Cookie Martinson 495, Kathy Herriges 482, Donna La Shay 474.

Indv. High Game: Pat Wietor 209, Donna La Shay 196, Cookie Martinson 184.

### CORRECTION

The New Fane Kettle Riders item in last week's issue should have read as follows: President - Dennis Seideman; Vice - President - Martin Haack; Secretary - Arlene Fischer; Treasurer - Marilyn Bohn, and Director - Glen Mueller.

## Kedinger First In Eagle River Snowmobile Race

Jim Kedinger of West Bend, manager of Ked-Web Sales & Service, Inc. in Kewaskum, was one of three drivers scoring victories in the only finals of the World's Championship Snowmobile Derby held at Eagle River, Wis. Friday afternoon.

Kedinger, driving a Yamaha, won the stock F class five lap final. Other winners were Harry Grantham of Wauconda, Ill., driving a Polaris in the Stock E class, and Richard Decker of Marshfield, Wis., driving a Moto Ski in the Mod Stock I Class.

### Friday's results:

#### Stock F 5 Lap Final

1. Jim Kedinger, West Bend, Wis., Yamaha; 2. Kenneth Goodman, Wheeling, Ill., Rupp; 3. Terry Hunt, Wonder Lake, Ill., Rupp. Stock E 5 Lap Final

1. Harry Grantham, Wauconda, Ill., Polaris; 2. Glen Thielke, Lakewood, Wis., Polaris; 3. Jeff Lau, Tracy, Minn., Polaris. Mod Stock I 5 Lap Final

1. Richard Decker, Marshfield, Wis., Moto Ski; 2. Harry Grantham, Wauconda, Ill., Polaris; 3. Glen Thielke, Lakewood, Wis., Polaris.

### QUEEN HITS LEAGUE

Ellen Breitzman, Sec.

Team	Won	Lost
Everglades	44	13
Bauer Spraying	35	22
Baumann's Bus	34	23
Dundee Sand, Gr	34	23
Charles	32½	24½
Herman's	32	26
Regal Ware	30	27
Strobel's	30	27
Johann Plumbing	26	31
Hensen's	26	31
Fin-n-Feather	25½	31½
Artie's Market	23½	33½
Gipper's	23	34
Laurie's	21	36
Newsettes	20	37
Gay Nineties	19½	37½

Indv. high game: Joyce Schultz 245, Linda Ertl 205, Kathy Edman 197.

Indv. high series: Joyce Schultz 553, Janet Serwe 553, Carol Heller 513, Barb Falk 507.

**FOR A SOLID JOB**

loaded with opportunities, check into the opportunities that the United States Air Force offers...opportunities that many young men and women find appealing...opportunities for training at some of the finest technical schools in the nation...to work toward a 2-year associate degree...to pick up that valuable on-the-job experience...to enroll in advanced (off-duty) education programs...to receive a worldwide assignment. There's more.

Find out today about these and the many other opportunities that go with an Air Force job. Contact **TSgt Kenneth Hibdon** Air Force Opportunities 7101 W. Capitol Dr. Milwaukee, Wis. 53216 Call Collect: 414-461-0800

**AIR FORCE**  
A great way of life.